



Mack Anthem[®]





Rediscover an American legend.

We took more than a century of experience building America and put it to work tackling the challenges of our industry. The result? The new Mack Anthem® —a truck that will make you rethink what's possible on the highway. Boldly designed and engineered tough, Anthem is born ready for whatever the road demands.

BUILT FOR YOUR BUSINESS.

Efficient in every sense of the word, Anthem saves on fuel and reduces maintenance costs while maximizing uptime—and your bottom line.

DESIGNED FOR THE DRIVER.

Anthem's cab design and driver environment are built around the way work gets done on the road, keeping drivers comfortable, safe and focused all day long.

Built for your business.



EFFICIENT DESIGN

The advanced aerodynamics and purpose-built design of Mack Anthem® put function at the forefront and reduce day-to-day costs.

DEPENDABLE SUPPORT

From parts and service to our 24/7 Uptime Center, Mack has the right combination of people and technology to keep you on the road.

THE STRENGTH OF A LEGEND

Anthem comes standard with our proprietary Mack® engines, transmissions and axles, delivering unrivaled performance and fuel efficiency.

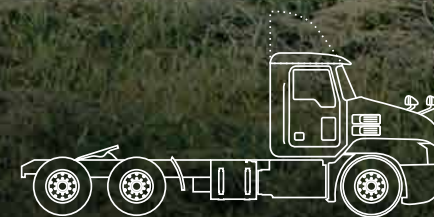

Day Cab

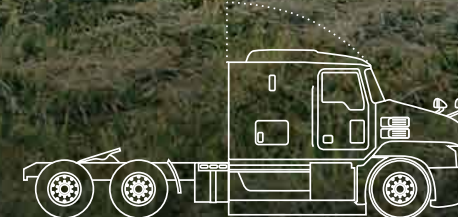

48-inch Flat Top Sleeper

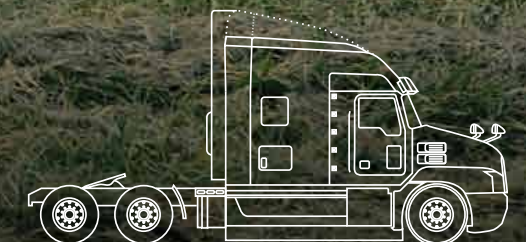

70-inch Stand Up Sleeper

Aerodynamic never looked so Mack.[®]

The new Mack Anthem[®] challenges the expectations of aerodynamic design with a bold look that dramatically improves efficiency up to 3%.



By displacing air to the sides, as well as over the hood and roof, Anthem cuts wind resistance and improves fuel economy by up to 3%. These aerodynamic fairings are at the core of the **Mack HE+ Package**, which arms an Anthem with the ultimate in fuel-efficient features.

Roof Fairings with Adjustable Trim Tab

Improves airflow from the cab to the trailer (70-inch Stand Up Sleeper only).

Hood Mirrors

Single support decreases wind resistance compared to tripod designs and folds on impact to prevent damage.

Hood and Fenders

Hood slope and fender design direct air over and around the trailer.

Close-Out Flange

Prevents airflow between hood and bumper and moves air around the cab.

Air Dam

Reduces turbulence under the vehicle for less drag.

Covered Tow Loops

Cut down on wind resistance and create a clean look.

Powered by Mack's integrated powertrain.

Engineered for efficiency and performance, and proudly assembled in Mack's Hagerstown, Maryland facility, our integrated powertrain is the toughest in the game. Bar none.

Mack® MP® Engines

With horsepower, torque and superior fuel economy, Mack's MP engines conquer the highway, mile after mile.

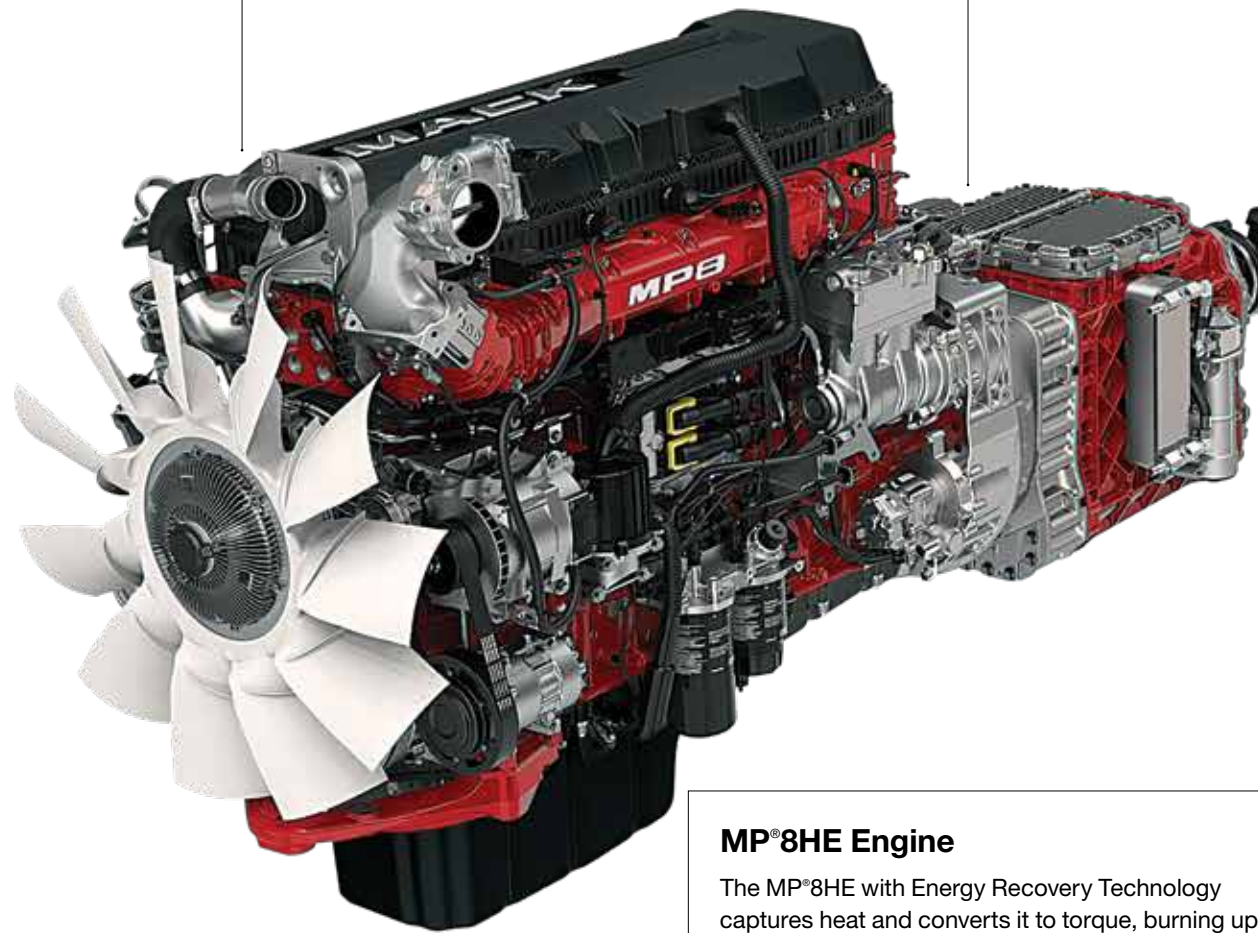

Mack Transmissions

Mack's transmissions are designed and built to perform at the highest level in the most demanding conditions, just like the rest of the truck.

Mack Axles

Built to handle long hauls and the relentless punishment of the road.

Mack Suspensions

Engineered to be lighter and stronger, for enhanced reliability and outstanding performance.



Wave Piston Design

By adding small waves to the piston bowl, the engine can burn fuel more efficiently for reduced fuel consumption and lower emissions.



Mack Wave Piston



Standard piston combustion efficiency

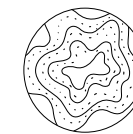

Mack Wave Piston combustion efficiency

MP®8HE Engine

The MP®8HE with Energy Recovery Technology captures heat and converts it to torque, burning up to 6.5% less fuel* in highway operations.

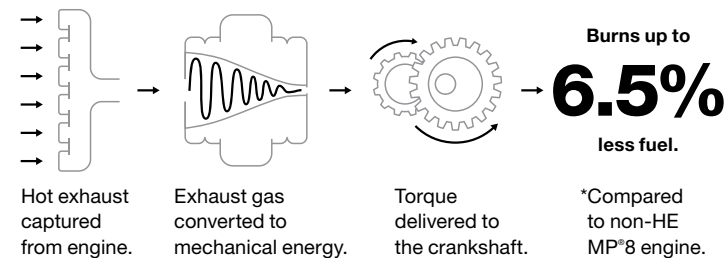

Natural Gas Engine

The Cummins Westport ISX12 G is a natural choice for heavy-duty vehicles. It drives emissions to near zero and brings up to 400 horsepower to demanding highway jobs. Mack offers factory-installed CNG tanks with an LNG option.



mDRIVE™

Mack's industry-leading automated manual transmission expands your driver base and reduces costs.



Smarter Hauling

mDRIVE™ continuously monitors changes in grade, acceleration, vehicle weight and more to optimize fuel economy.

Easy to Operate

Drivers can manage mDRIVE with just the press of a button, making it more comfortable and easier to operate, even for new drivers.

Minimal Service

Proven technology and superior design mean mDRIVE requires minimal service, significantly reducing maintenance costs and downtime.

The ultimate in fuel efficiency.

The Mack® HE+ Package combines an MP®8HE engine with distinctive aerodynamic and fuel economy features, like roof fairings and a sloped hood, to minimize drag, maximize profit and increase fuel efficiency up to 9.5%*.



MACK HE+ PACKAGE FUEL SAVINGS

Outfit your Mack Anthem® with the ultimate in fuel-efficient features.

3% from enhanced aerodynamics
+ **6.5%** from MP®8HE engine upgrade

9.5%

FUEL ECONOMY IMPROVEMENT*

SAVE UP TO

1,900

GALLONS PER YEAR

THAT'S NEARLY

\$5,700

SAVINGS PER YEAR**

*Compared to similar Mack Anthem without HE engine and HE+ features.
**Using 20,000 gallons of fuel with an average fuel price of \$3.00 per gallon.

Built to last.

Mack Anthem[®] drives down operating costs with durability that stands up to the rigors of the road and keeps you out of the shop.



Breakaway Hood Mirrors

The mounts are spring-loaded to rotate when hit, preventing damage to the hood and lowering parts and repair costs.

Breakaway Side Mirrors

Strong hinges with zero plastic, tougher materials and spring-loaded mounts help keep maintenance costs down.

Durable Components

From bolts to latches, all Anthem components are made from tough, long-lasting materials.

LED Lights

LED headlights are 66% brighter, last longer, use less energy and provide better visibility.

Smart serviceability.

The Mack Anthem[®] tilt-assist hood and functional, modular design allow service professionals to access, repair and replace components more quickly.

EFFICIENT ENGINE ACCESS

Mack[®] MP[®] Engine

Single-Point Latch and Tilt Assist

Requires 50% less effort to open for easy access to the engine.

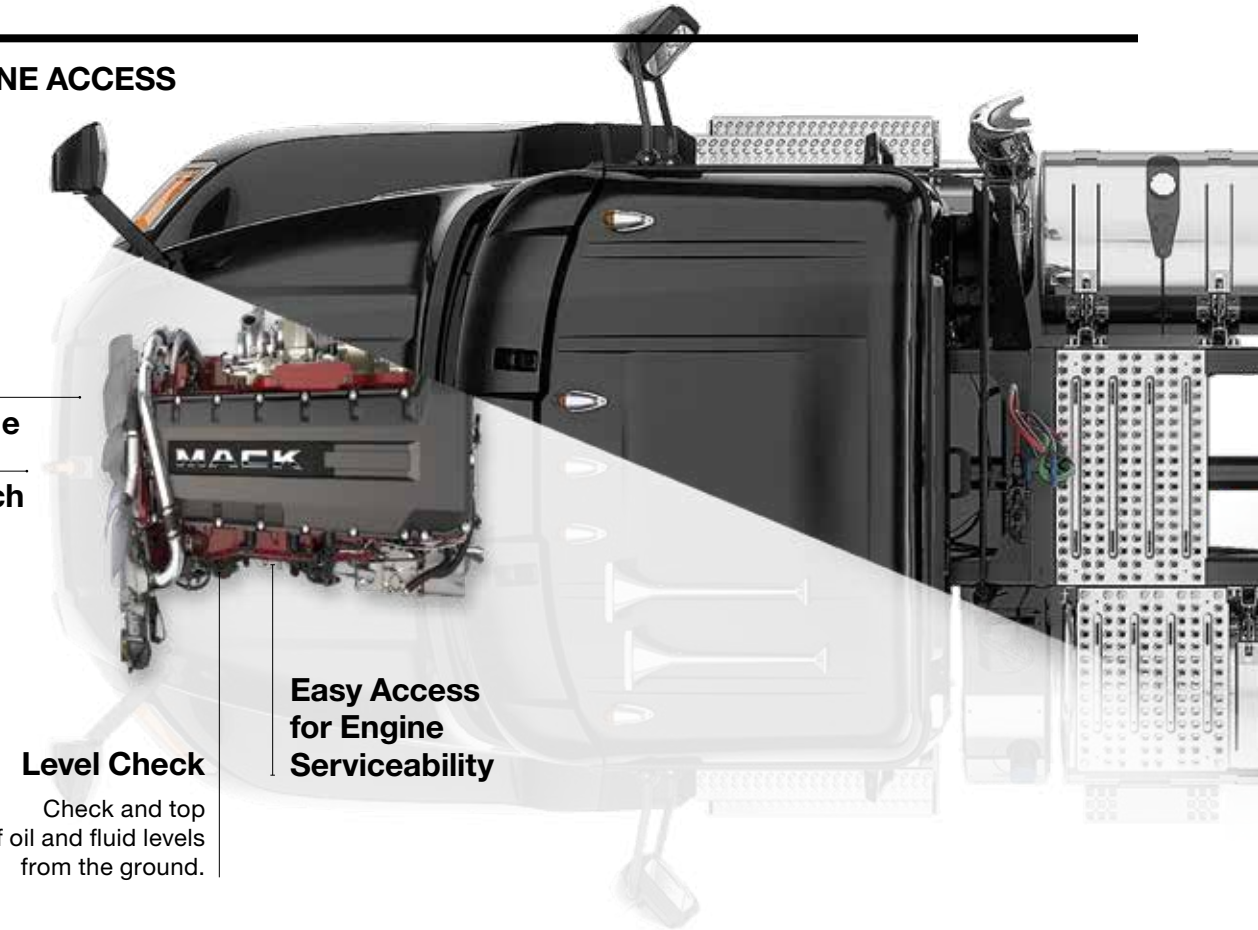

Level Check

Check and top off oil and fluid levels from the ground.

Easy Access for Engine Serviceability

3-PIECE HOOD

The 3 pieces are bonded together but can be separated and repaired individually for lower replacement costs.



3-PIECE BUMPER

The 3 pieces can be ordered as separate replacement parts for improved serviceability and lower repair costs.



With Mack® Connect, it's uptime all the time.

Mack's exclusive uptime and productivity solution, Mack Connect, combines intelligent software, predictive analytics, driver assist technologies and more to help you keep your trucks—and your business—moving forward.

Connected Driving



Connected Business



Connected Support



CONNECTED BUSINESS

To succeed in the modern trucking industry, you need to run a modern trucking company. Drive profitability and gain insights at every turn with Mack's fleet management systems. Our open platform sends vehicle data directly to your own fleet management software for analysis, so you're not locked into a proprietary system. Partners include:

Verizon Connect

Advanced fleet management and compliance tools that integrate directly with Mack® GuardDog® Connect or your own smartphone, tablet or other connected device.

Omnitracs

Integrated telematics providing real-time insights into vehicle location and driver behaviors.

WheresMyConcrete

Real-time data for dispatch, transparency for customers and critical analytics to improve operations.

Geotab®

Business intelligence and benchmarking data for older fleets to improve productivity, reduce fuel consumption, enhance driver safety and improve compliance.



CONNECTED SUPPORT

Your trucks are only profitable when they're on the road and on the job. Maximize your uptime with intelligent maintenance systems and time-saving repair processes.

Over The Air (OTA) Software Updates

Wirelessly updates software without disrupting your schedules, while increasing operational efficiency and uptime. Requires GuardDogConnect.

GuardDog Connect

GuardDog Connect automatically monitors your truck's performance and quickly alerts OneCall® of any maintenance or repair needs. OneCall's 24/7 support and roadside assistance leverages Mack® ASIST to give drivers, dealers and Uptime Center staff access to all of the repair information they need—all while you're still on the road.

Certified Uptime Dealers

Dealers identify quick fixes and put them in the fast lane for completion, while giving larger repairs the attention they need and putting you back on the road faster.

Preventive Maintenance

Keeps your trucks in top shape by planning a service schedule that matches the usage and miles of your vehicle, so we can repair or replace components before it impacts your business.



CONNECTED DRIVING

The trucking business is all about making margins and driving efficiency. Get the most out of your trucks and your drivers with built-in fuel management and driver assist technologies.

Mack Predictive Cruise

Proprietary Mack technology that stores hilly terrain in GPS data to optimize engine speed and fuel efficiency on saved routes.

Information and Entertainment

Bluetooth®, satellite radio, cell phone integration and more to make life on the road as enjoyable as possible.

Bendix® Wingman® Fusion™

Driver assist and safety technology combining radar, camera, brakes and the SafetyDirect® web portal from the leader in collision mitigation.

Roll Stability

The Bendix® ESP® full-stability system helps drivers mitigate rollovers and loss-of-control in situations on wet and dry roadways through advanced sensors and throttle and braking interventions.

Collision Avoidance

Automatically alerts the driver and, if needed, applies the foundation brakes to mitigate or prevent a potential collision with a forward moving vehicle or stationary object.

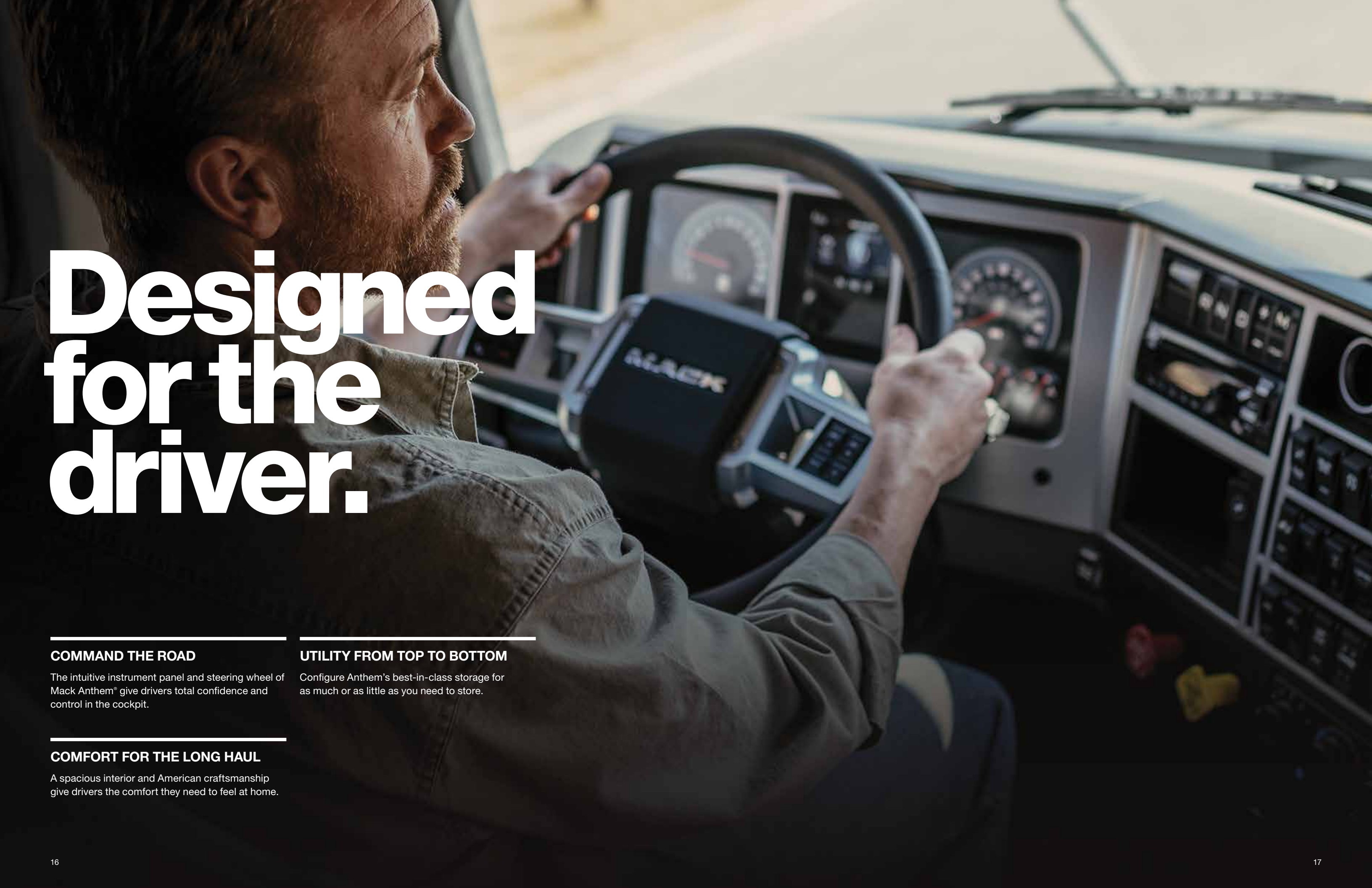

Designed for the driver.

COMMAND THE ROAD

The intuitive instrument panel and steering wheel of Mack Anthem® give drivers total confidence and control in the cockpit.

UTILITY FROM TOP TO BOTTOM

Configure Anthem's best-in-class storage for as much or as little as you need to store.

COMFORT FOR THE LONG HAUL

A spacious interior and American craftsmanship give drivers the comfort they need to feel at home.

Control at your fingertips.

Built to work and designed with purpose, the automotive-inspired controls of Mack Anthem® make operation easy, safe and comfortable.

Illuminated Controls

Keep eyes on the road with familiar, automotive-style controls.

Flat-Bottom Steering Wheel

An industry-first, allowing more belly room and clearance for entry or exit. Add to that a racecar-style grip, enhanced dash visibility and clipboard-friendly surface for better control and maximum comfort.

Information and Entertainment Display

7" touchscreen, along with smart steering wheel buttons, manages tools like SiriusXM®, Weather Band, TomTom truck navigation, Apple CarPlay and optional back-up camera.

D-Panel Gauges

Customize the dash with 4 optional auxiliary gauges.

Power Window, Lock and Mirror Controls

Provide more comfort and control than manual windows.

Light Control Module

Runs all exterior lights from one place with an automotive feel.

Rocker Switches

New larger, robust rocker switches are laser etched to be readable for life.

mDRIVE™ Controls

Intuitive placement—and the option to install it even higher on the dash—gives drivers comfortable access without taking eyes off the road.

Right Stalk

Manages engine brake and Co-Pilot™.

Left Stalk

Manages high beams, self-canceling turn signals and wipers.

Information at a glance. Eyes on the road.

Drivers manage constant demands on their attention. The Mack Anthem[®] instrument panel brings important information to the forefront, keeping it clear and readable so drivers can stay focused on the road ahead.

Digital-Analog Gauges

Solid dial hands with the precision of digital instruments.

Mack[®] Co-Pilot™

5" full-color digital display provides enhanced visibility and simpler navigation without distractions. Constant truck monitoring and Pre-Trip Assistant, including one-person Exterior Light Inspection, help keep an eye out for potential issues before they become real ones.



Unmatched comfort.

The spacious cab, stand up sleeper and premium materials of Mack Anthem® create an interior that's as comfortable as it is functional.

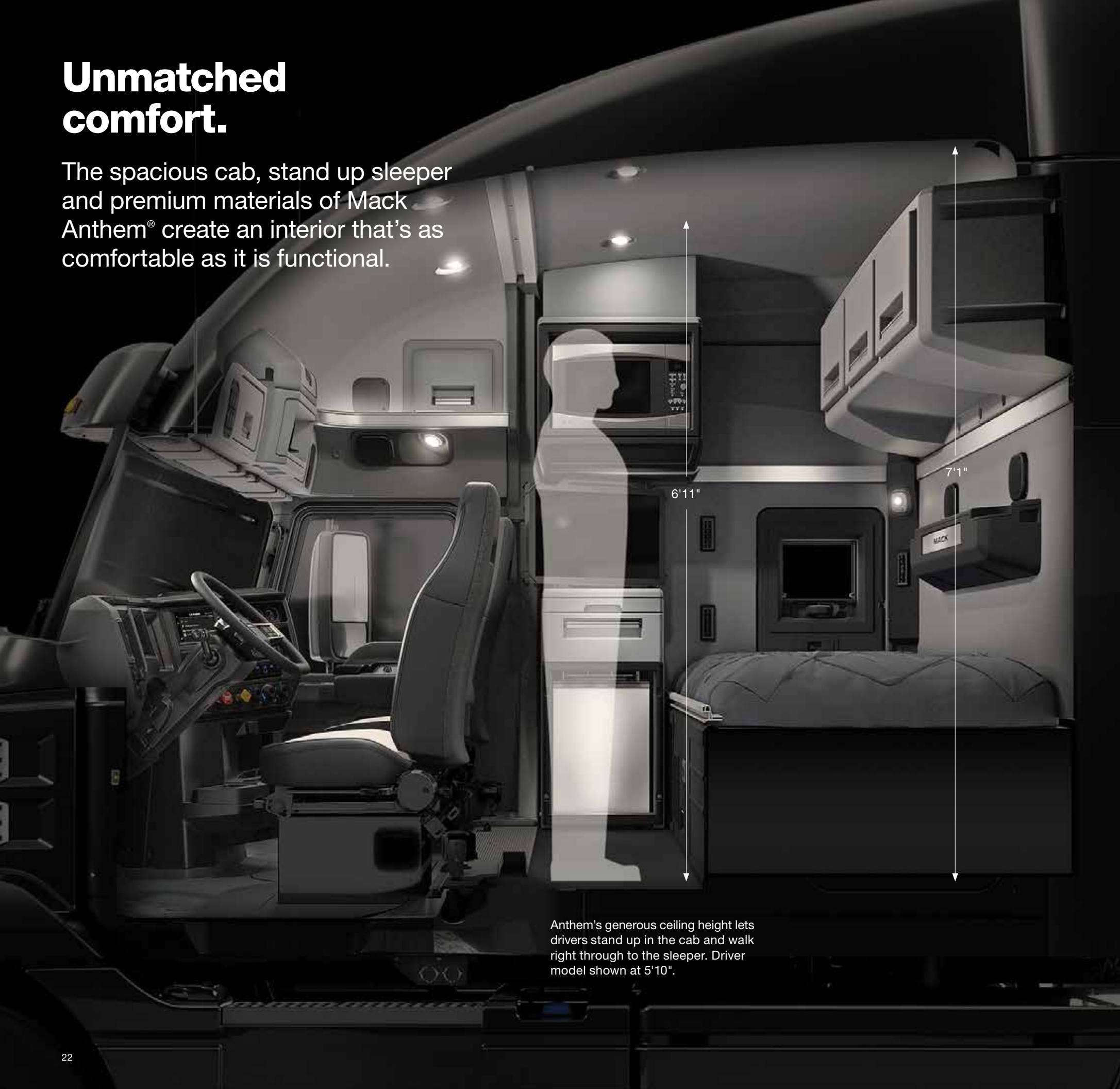

Anthem's generous ceiling height lets drivers stand up in the cab and walk right through to the sleeper. Driver model shown at 5'10".



Mack-Exclusive Seats

We partnered with Sears Seating to build seats that improve driver comfort and support, while taking on daily wear and tear.

- ▶ Air suspension
- ▶ Optional swivel base
- ▶ 30+ feature and fabric combinations



Sleeper Windows



Sleeper Control Panel



Sleeper Lighting



Amenities



Flexible Work Space

Home away from home.

We built the the Mack Anthem® 70-inch Stand Up Sleeper with 35% more space to give drivers plenty of room to get comfortable, rest well and stay focused on the road.

SLEEPER WINDOWS

Sleeper windows feature self-contained built-in shades that block 100% of light. The screened windows tilt out to let air in and keep rain out.

SLEEPER CONTROL PANEL

Access power outlets and USB ports and control the sleeper stereo, interior lighting and high-performing HVAC from one convenient panel.

SLEEPER LIGHTING

Dimmable pipe light around the perimeter of the driver environment, bunk task light, reading lights and overhead lights are all bright, long-lasting LED.

AMENITIES

Opt for a spacious, stainless steel refrigerator or choose from prep kits—including power outlets—for a refrigerator, microwave or flat-screen TV. Add cup holders with integrated storage above the bottom bunk for easy access to everything.

FLEXIBLE WORK SPACE

Versatile pullout surfaces behind the driver and passenger seats create a comfortable space for a meal or catching up on email.

IDLE-FREE POWER

Idle Free® electric APU lets drivers run the HVAC system without idling, saving fuel and maintenance costs.



Front Overhead Console

Generous storage with tough materials, interior LED light controls and a dedicated CB radio box.

Side Overhead Cabinets

Deep storage areas above the driver and passenger doors create a secure space for gear in the 70-inch Stand Up Sleeper.

Non-Slip Electronics Tray

Charge electronics securely with the USB port, phone holder and non-slip rubber fuse relay center cover.

Safe, secure storage.

Even on rough roads, electronics, drinks and gear stay in place with the industry-leading storage of Mack Anthem®.

Additional Storage

Oversized cup holders fit large drinks and there's room for keys, devices and more in the easy-to-clean unit.

Everything in its place.

Mack Anthem® offers cabinets, work surfaces, wardrobes and shelving to keep the living space organized, functional and ready to work.



Under Bunk Storage
Illuminated, 3-compartment storage.



Bunk Wall Storage
Back wall cup holder and open storage bin or 3-cabinet overhead storage (single bunk only).



Driver Side Storage

Tall wardrobe cabinet with hanger bar, interior mirror and magazine slots.

Cabinet with shelves, drawer and pullout work surface.



Passenger Side Storage

Microwave cabinet, DVD/storage slot, top storage.

TV prep kit (up to 24" flat panel), mounting brackets, power outlet.

Drawer-style refrigerator and storage drawer.

Microwave, TV and refrigerator spaces are also available as cabinets.

Your Mack Anthem[®]. Your way.

EXCLUSIVE MACK ANTHEM PAINT COLORS AND EXTERIOR TRIM



Mack[®] Black
Axalta 932844



Graphite Gray
Axalta 932850



Liquid Silver
Axalta 932849



Arctic White
Axalta 932845



Lacquer Red
Axalta 932847



Cobalt Blue
Axalta 932846

Exterior Trim



Mountain Green
Axalta 932848



Bold Black



Mirror Chrome Bright

BUNKS AND STORAGE

Single Bunk
with lower storage



Single Bunk
with full storage



Double Bunk
with full storage



Additional storage options available; contact your Mack dealer for more information.



DASH AND INTERIOR TRIM PACKAGES



Standard



-  Gunmetal dash
-  Charcoal door trim
-  Steel Gray interior trim
-  Interior trim also available in Sierra Tan (Day Cab only)

Premium

-  Aluminum dash and door trim
-  Steel Gray interior trim
-  Interior trim also available in Sierra Tan (Day Cab only)

Ultra

(70-inch Stand Up Sleeper only)

-  Woodgrain dash and door trim
-  Steel Gray interior trim with Dark Saddle inserts

SEATS



Standard

Durable vinyl construction for low maintenance and easy cleaning.



Premium

Vinyl construction and cloth inserts combine style with performance.



Ultra

Ultraleather® in Dark Saddle for a premium feel that delivers comfort and durability.

STEERING WHEELS



Standard

Urethane foam rim
Gunmetal spokes
All controls located on the D-panel
Also available with steering wheel controls and Satin Aluminum spokes



Premium

Leather-wrapped rim
Leather horn pad
Satin Aluminum spokes
Steering wheel controls



Ultra

(70-inch Stand Up Sleeper only)
Leather-wrapped rim with Dark Saddle leather inserts
Leather horn pad
Satin Aluminum spokes
Steering wheel controls

READY-TO-ORDER PACKAGES

Mack Anthem® is fully customizable for your needs, budget and application. For simpler ordering, we've built three interior package options to choose from.

| | STANDARD | PREMIUM | ULTRA |
|----------------------------------|--|--|--|
| Dash and Door Trim Pieces | Gunmetal dash and Charcoal door trim | Aluminum dash and door trim with stitched door insert panel | Woodgrain dash and door trim Ultraleather® diamond-embossed door insert panels, Ultraleather® diamond-embossed sleeper side- and rear-wall panels, soft-touch headliner |
| Interior | Steel Gray Also available in Sierra Tan (Day Cab only) | Steel Gray Also available in Sierra Tan (Day Cab only) | Steel Gray/Dark Saddle |
| Steering Wheel | Foam—Gunmetal spokes without control switches Upgrade option: Foam grip with aluminum spokes with control switches | Premium leather steering wheel—Aluminum spokes with control switches | Premium leather steering wheel with Dark Saddle leather accent—Aluminum spokes with control switches |
| Seats | Vinyl Upgrade option: Vinyl with cloth inserts | Vinyl with cloth inserts Upgrade option: Ultraleather® seats | Ultraleather® with Dark Saddle diamond-embossed leather inserts |
| Radio and Speakers | Standard | Premium radio Premium speakers | Premium+ with aux amp and subwoofer, woofers, tweeters and full range |
| Floor Covering | Polyurethane | Polyurethane with inserts | Polyurethane with inserts |
| Overhead Console | 3-bin netted storage (Day Cab and 48-inch Flat Top Sleeper) 3-bin storage with doors, dedicated CB radio space and 2 optional above-door bins with doors (70-inch Stand Up Sleeper) | 3-bin netted storage (Day Cab and 48-inch Flat Top Sleeper) 3-bin storage with doors, dedicated CB radio space and 2 optional above-door bins with doors (70-inch Stand Up Sleeper) | 3-bin storage with doors, dedicated CB radio space and 2 above-door bins with doors |
| Door Controls | Power windows and locks Upgrade option: motorized and heated side mirrors | Power windows and locks Upgrade option: motorized and heated side mirrors | Power windows and locks with motorized and heated side mirrors |



Support at every turn.

Nearly 600 authorized dealers and parts and service locations coast to coast. Nearly 1,400 Master Technicians. When you need assistance, the Mack network is ready to deliver.

CERTIFIED UPTIME DEALERS

Average trucking industry dwell time for a repair is 4 days, but the average repair actually takes less than 4 hours. Mack's Certified Uptime Dealers identify the quick fixes and put them in the fast lane for completion, while giving larger repairs the attention they need.

INVESTING IN SERVICE

The Mack Dealer Network is committed to quick, quality service. That's why our dealers have invested nearly \$600 million since 2010 to modernize facilities, improve access to parts and train service professionals to help get you back on the road.

FAMILY EXPERIENCE

Whether you're behind the wheel or managing the fleet, when you run with Mack, you're part of the family. That means you'll always get personalized attention and the support you need to keep your business running strong. Just pick up the phone; there's always a real person ready at the other end of the line. Mack OneCall®: 1-800-866-1177.





1-800-922-MACK
MackTrucks.com

©2019 Mack Trucks, Inc.

 facebook.com/MackTrucks

 twitter.com/MackTrucks

 youtube.com/MackTrucks

 linkedin.com/company/Mack-Trucks

 instagram.com/MackTrucks