



Refuse





**OUT HERE,
IT'S PICK UP
OR SHUT UP.**



Undisputed performance from the leader.

Mack's lineup of refuse trucks dominates the industry. From commercial to residential jobs, when you want the work done right, turn to the trucks that do it best.



FRONT AND REAR LOADERS

Superior forward visibility and efficient use of chassis space mean you're able to confidently navigate tight spaces.



TRANSFER

Strong Mack® axles, suspensions and transmissions, including the *mDRIVE™* HD, give drivers the durability needed for rugged transfer applications that can stretch hundreds of miles.



SIDE LOADER

Do more with Mack. Our application excellence shines in advanced automated refuse collection vehicles with maximum driver productivity.



ROLL OFF

Our versatile chassis are built tough to withstand the full abuse of refuse applications.

The rulers of the industry.

For over a century, Mack has led the charge when it comes to hauling refuse. And the refuse models Mack builds today aggressively defend that legacy—and push it forward—with best-in-class versatility and strength.



TerraPro® Cabover



LR Model



Anthem



Granite® & Granite® MHD

TerraPro®

Built to perform the toughest jobs in the tightest spaces, TerraPro is the refuse industry's best-selling cabover. Ideal for industrial and commercial applications, this truck improves productivity and reduces downtime while providing all-out cabin comfort.

Exceptional visibility

TerraPro's large mirrors combined with the most forward window glass in the industry create superior visibility so you can keep pedestrians, other vehicles and side-loading jobs safely in view.

Alternative fuels

TerraPro natural gas models use LNG or CNG for lower overall lifecycle and fuel costs, as well as lower greenhouse gas (CO₂) emissions and reduced carbon footprint.

Body-ready electrical system

Cabovers come equipped with body-ready electrical systems so installation time is reduced. These systems ensure quality and prevent future reliability issues.

Axle configurations

Available in single and tandem configurations, TerraPro can be customized with multiple drive and auxiliary axle combinations.

Improved productivity

Mack's long experience with all aspects of the refuse industry means we know how to boost your productivity. The fuel-efficient yet high-torque Mack® MP7 engine delivers faster route times and less downtime. And Mack's chassis engineering packs the maximum allowable payload into a compact overall dimension.

Capture comfort

Mack's contemporary cab provides ergonomic seats and controls to create an optimal driving experience.

Superior maneuverability

With a short wheelbase, slimmer width and more compact design from bumper to back of cab, TerraPro's cabover design makes navigating even the most congested neighborhoods safer and more efficient.

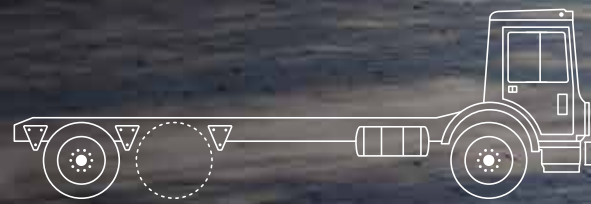



Mack® LR Model

The Mack LR model is unlike any truck on the market. It puts the driver's needs first with upgraded features designed to provide greater visibility and comfort for increased productivity. When you call for a truck to help tackle the demands of your day-to-day, Mack answers.

Superior visibility

Side loading and maneuvering narrow streets are made easier with rear wrap-around windows that increase your field of vision where you need it most.

One-step entry and exit

Low cab floor height (17 inches) and large grab handles help drivers get in and out with minimal effort and reduce the physical demands of curbside pickup operations.

Work brake

Operate your braking system with ease. A hand-operated work brake allows drivers to go from start to stop by parking the truck on its service brakes with one simple motion. That means less wear and tear and more productivity.

GuardDog® Connect

Mack's GuardDog Connect telematics platform comes standard on our LR model. GuardDog Connect monitors your truck in real time for potential issues and starts the support process sooner—most times before the driver knows there's a problem.

Expanded storage

These trucks make the most of cab space by packing in more storage than you thought possible. A centrally located storage platform creates a convenient spot to keep paperwork, a cell phone or an MP3 player—with extra room for a lunch box. Add cup holders for regular and large bottles, and there's a fit for everything on the job.

Ergonomic design

When it comes to taking command of demanding jobs, comfort is key. The LR model's extended cab offers more room to do the job your way. A tilt and telescopic steering column, new seat positions, suspended pedals, knee bolsters and arm rests let drivers adjust their truck for improved comfort and efficiency. Plus, the integrated air conditioner provides a factory-installed climate-controlled environment that supplies relief on the hottest days.

Chassis configurations

Designed for easy body installation, the LR model is available in single and tandem drive configurations.

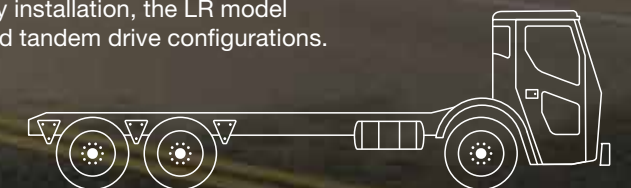

The LR model: Design your ideal drive.



Wraparound Windows



Driver Information Display



Integrated Air Conditioning



Expanded Storage Platform



USB and Bluetooth Connectivity

Mack's tradition of application excellence means you do more than get the job done—you own it. Our LR model offers multiple driving and door options to eliminate downtime and keep the driver firmly and efficiently in charge of the workday.

Four driving configurations

Whether you need standup or seated driving, right-hand, left-hand or even dual steering positions, LR covers them all, giving you the

best choice for each job. Mack gives you the choices you need to succeed.



Standup

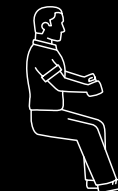

Seated

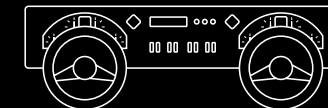

Left-hand



Right-hand

Multiple Door Configurations

Open the door to productivity. The LR model has some of the largest doors in the industry for easy entry and exit, with three door configurations and

six door combinations to suit your needs. Choose between standard, flip and bi-fold designs, and step into an easier way to work.

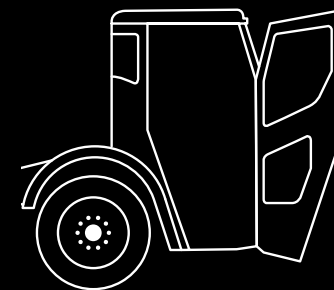

Standard Door

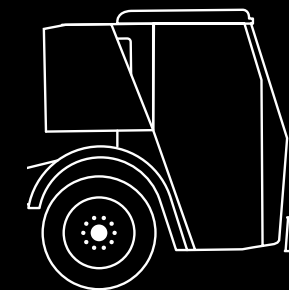

Flip Door

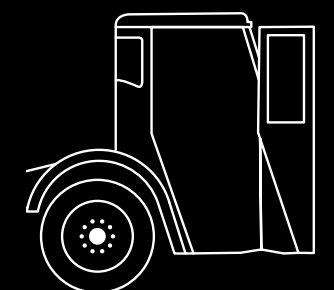

Bi-fold Door



Granite® & Granite® MHD

To endure the daily grind of the refuse industry, you need a truck that's built stronger than the job itself. Granite is built to deliver maximum power while Granite Medium Heavy Duty (MHD) is spec'd for lighter-duty applications, and both vehicles are nothing less than tough and versatile.

Maneuverability

Get a shorter truck with a tighter turning radius. Compact component packaging and a wide pivot significantly improve your overall maneuverability on the job.

Heavy-duty crossmembers

Drive durability with heavy-duty crossmembers to give your truck the strength to stand up against the relentless pounding of the refuse industry.

Strong suspensions

Mack doesn't compromise on toughness. Our suspensions are built strong and reliable to take on any refuse jobs, no matter how severe.

Frame rail versatility

A choice of rail widths offers increased flexibility so that your Granite comes ready for the rigors of refuse.

Compact fuel tanks

When you're trying to fit your truck into tight spots, shorter overall length is better. Compact fuel tanks mean you have everything you need, and nothing you don't.

Cornerstone™ chassis

Our stronger, lighter frames are made from high-yield steel and formed steel plate crossmembers. With nine different frame rail options for a host of applications, we've got a design perfect for your job no matter how tough it is.

Axle configurations

Available in single, tandem and tridem configurations, Granite and Granite MHD can be customized with multiple drive and auxiliary axle combinations.

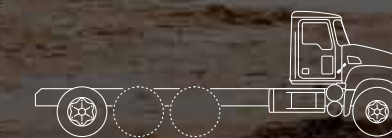

Granite

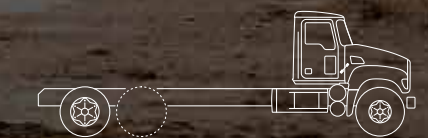

Granite MHD

Refuse Transfer

It doesn't matter if you're transporting a heavy load or deadheading, you want a powerful truck to propel you from the transfer station to the landfill and back again, without sacrificing efficiency. You want the proven axle-forward Mack® Pinnacle™ or axle-back Mack Anthem®.

Fuel efficiency

Whether you're deadheading or driving a full load, your truck is using fuel. That's why Mack trucks are engineered to offer maximum fuel efficiency for both job conditions.

Unyielding frame

Mack trucks are built to shrug off the abuse of the job. Maintain your truck's strength with heavy-duty crossmembers and frame rails, offered in multiple sizes to best fit your needs.

Ideal driver environment

It's all about productivity. Our ergonomic interiors combine quiet comfort, enhanced visibility and a functional instrument cluster to keep drivers happy and safe.

mDRIVE™ HD

Heavy loads can be hauled hundreds of miles. That's why mDRIVE automated manual transmissions are designed to make pulling big loads easier, safer and smarter. Available with an extended range of gears—including 12-, 13- and 14-speed versions.

Rugged balance

These aren't your typical trucks. Made with sturdy axles and suspensions to maintain a lightweight ride, they're strong enough to travel off-road, but light enough to make the most of your payload.

Axle configurations

Available in single, tandem and tridem configurations, and can be customized with multiple drive and auxiliary axle combinations.

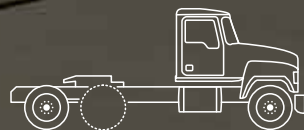

Pinnacle Axle Forward

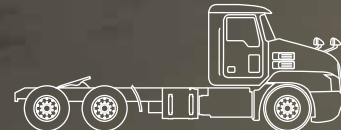

Anthem Axle Back



Integrated powertrain? Try integrated everything.

It's one thing to invent the integrated powertrain. We did that more than 100 years ago, and today our revolutionary powertrain sets the gold standard.



MP® Engine Series

With muscle, torque and great fuel economy, Mack® MP engines conquer the workday, mile after mile.

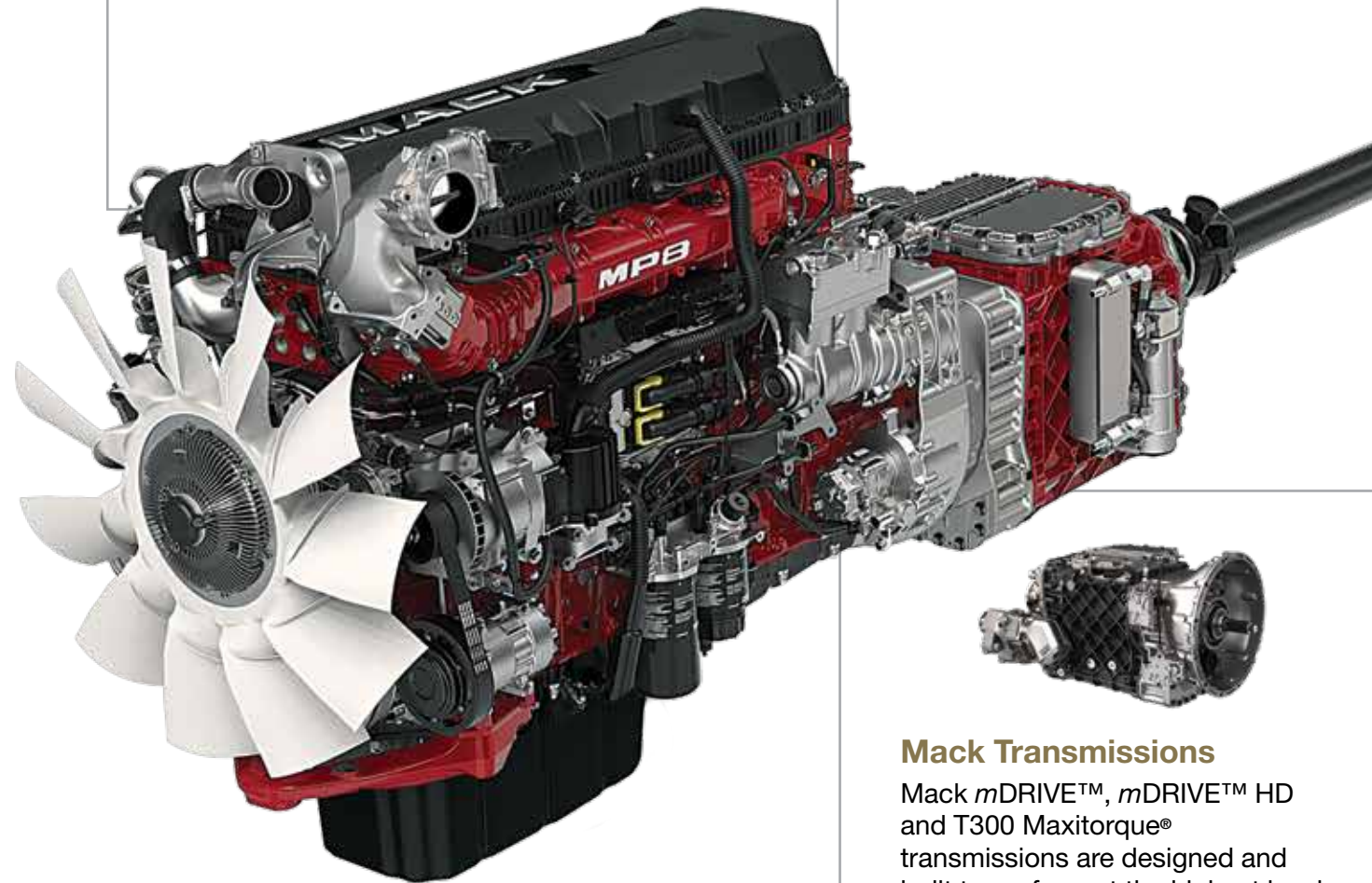

Mack Transmissions

Mack *mDRIVE™*, *mDRIVE™* HD and T300 Maxitorque® transmissions are designed and built to perform at the highest level in the most demanding conditions, just like the rest of the truck.



Mack Axles

Mack axles and carriers are engineered to handle heavy hauls and the relentless punishment of the road.



Mack Suspensions

We've engineered Mack suspensions for reliability and outstanding performance no matter where you go. Which, in a Mack truck, can be almost anywhere.



Now, we've gone ahead and integrated the whole truck operating experience. From financing to service to 24/7 support, Mack has taken uptime and productivity to a whole new level.



Mack Electronics

Featuring proven V-MAC® IV electronics, Mack makes it easier to work the way you want. Effortlessly manage your truck and engine, so you save on fuel and boost your bottom line.

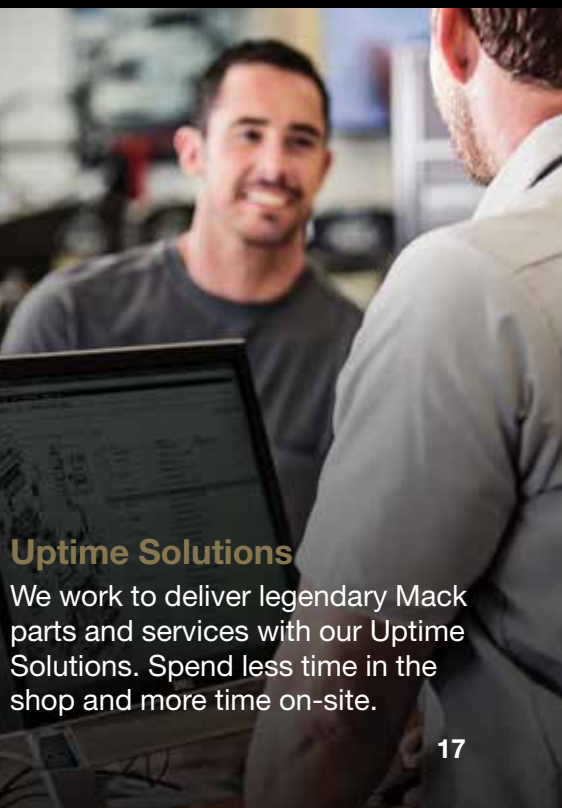

Uptime Solutions

We work to deliver legendary Mack parts and services with our Uptime Solutions. Spend less time in the shop and more time on-site.

Weighs less. Carries more.

Armed with the transmission that won't weigh you down, you're up for any challenge.



MACK® *mDRIVE*™ HD NOW WITH CREEPER GEARS

Mack's *mDRIVE* HD is the heavy-duty automated manual transmission that maximizes performance and fuel economy while reducing driver fatigue. It's available with an extended range of gears—12-speed, plus 13- and 14-speed versions with multi-speed reverse gears.

MACK T300 MAXITORQUE® TRANSMISSION

Available on the Mack Pinnacle™ and Mack Granite® refuse models, the powerful Maxitorque transmission is available in 9 to 18 speeds. It features the industry's only triple-countershaft design and easy shifting for increased durability and smooth gear transitions. Maxitorque has more PTO positions than any other transmission to help you master the demands of the job.

ALLISON® AUTOMATIC TRANSMISSION

Granite, TerraPro® and LR models are available with a choice of Allison 3000 and 4500 series automatic transmissions, making it simple to match your application to the right transmission for the job.



Mack MP® engine series.

Mack's evolved engine enhancements reduce weight and increase efficiency so you can haul more, and use less fuel to do it.

COMMON RAIL FUEL SYSTEM

Delivers pre- and post-combustion injections for more power and efficiency.

WAVE PISTON

Creates more complete combustion to increase fuel economy and reduce soot.

LESS MAINTENANCE

Two-piece valve cover, shimless rockers and simplified low-pressure fuel system improve reliability, serviceability and efficiency over the life of your engine.



MP®7

The 11-liter MP7 engine is built for optimal fuel efficiency. Available in Mack Granite, TerraPro and LR models, this lightweight engine has evolved to run even cleaner. It emits less CO₂ than ever before while maintaining a HP range from 325 to 425 HP and torque ratings from 1,260–1,560 lb.-ft.



MP®8

The MP8 blends fuel economy, power and increased uptime. Offered on Granite and TerraPro models, the latest evolution of this 13-liter engine is designed to meet even stricter emissions standards and deliver optimal HP range from 415 to 505 HP with torque from 1,660–1,860 lb.-ft.



MACK CLARETECH™ ONE

Mack knows emissions control systems, so we took ours one step further to optimize the overall package—and the result is ClearTech One. This new and improved exhaust aftertreatment system (EATS) is lighter and takes up less space, which saves fuel and money while improving flexibility.

Tough enough for the roughest roads.

Axles and suspensions provide the foundation for Mack's reputation of rugged reliability. They offer increased durability for a smoother ride, because the only thing you should feel on the road is complete control.



MACK® AXLES

Proprietary Mack axles provide greater performance on the most demanding jobs. Our C150/151, C180/181 and 200 Series axle carriers deliver great fuel economy and improved reliability.

MACK® CAMELBACK

The Camelback suspension is built with increased stability to handle the stress of on- and off-road refuse applications. This tried-and-true suspension allows for better steering. Camelback is available from 38,000- to 58,000-lb. ratings on TerraPro® and Granite® refuse trucks.



Clean up at the pump.

Fill up with pride. The natural-gas-powered TerraPro[®], Mack Anthem[®] and LR model refuse trucks combine fuel choice with the savings you demand. We've partnered with the leading natural gas engine manufacturer, Cummins Westport, to deliver the best alternative fuel technology to power your business.

SEE SAVINGS AT THE PUMP

Whether you're operating one truck or an entire fleet, it's all about boosting your bottom line. TerraPro and LR model natural gas trucks are capable of running on compressed natural gas (CNG), liquid natural gas (LNG), landfill gas (LFG) or hydrogen-compressed natural gas (HCNG). This leads to lower overall lifecycle costs and greater savings to pump back into your business.

ACCEPT NO SACRIFICES

Don't sacrifice when choosing your truck. Mack offers a complete suite of products for natural gas models. That means when deciding between alternative fuel and diesel, you won't have to make concessions to meet your refuse needs.

THE BEST OF BOTH WORLDS

The TerraPro and LR model trucks meet current EPA and CARB emissions levels by lessening the carbon footprint and lowering greenhouse (CO₂) emissions. And because natural gas is readily available in North America, they're also reducing this country's dependency on foreign fuel.

NATURAL GAS ENGINE

The Cummins Westport L9N engine is a natural choice for heavy-duty vehicles like the TerraPro and LR model. It drives emissions to near zero and brings up to 320 HP to demanding refuse jobs. Mack offers factory-installed CNG tanks with an LNG option on the Mack Anthem.



Everything your Mack® needs. Every place you need it. America's truck knows no boundaries.



NETWORK SUPPORT

Mack Dealer Network

Every Mack is supported by more than 400 authorized dealer and parts and service locations. These dedicated locations have invested in a level of service fit for a Mack truck—ensuring that you are greeted by knowledgeable staff, that you get in and out quickly and that your truck gets fixed right the first time.

Parts Purchasing

Mack makes it easy to get the right parts at the right time. From parts programs for entire fleets to a web-based program that provides 24/7 access to parts, we make sure you have access to the parts you need, when you need them.

Customer Training

When you purchase a truck from Mack, Mack Trucks Academy offers best-in-class training for your shop staff to improve uptime and your bottom line. Choose from instructor-led or online training to get your staff up to speed.

Body Builder Support

Mack simplifies support services with a focused Body Builder Support Group that offers prompt access to Mack experts who can answer questions while spec'ing a truck or during the body upfit process.

UPTIME SOLUTIONS

GuardDog® Connect

GuardDog Connect monitors your vehicle's performance the entire time it's operating to enable quick diagnosis of issues, schedule repairs and order parts—all while the truck is still on the road. With GuardDog Connect, you're always connected to a 24/7 network of support staff and repair centers, so you stay on schedule.

OneCall®

Mack OneCall provides 24/7 support for your truck. It combines an unparalleled customer support network with a state-of-the-art Uptime Center to bring the experts you need together under one roof.

Certified Uptime Dealers

Average industry dwell time for a repair is 4 days, but the average repair takes less than 4 hours. Our Certified Uptime Dealers identify the quick fixes and put them in the fast lane for completion, while giving larger repairs the attention they need. It's another way that Mack keeps you up and running.

ASIST

Mack ASIST is a web-based system that assembles consistent, complete and professional estimates of service recommendations, regardless of which dealer in the Mack network performs the service. ASIST gives you, the dealer and Uptime Center staff access to all information, getting you back on the road faster.

Diagnostic Tools

Mack's easy-to-use, PC-based diagnostic software gives you access to the information you need. From quick diagnostics to EPA emission data and key metrics for Mack trucks with Mack engines, you can monitor your fleet in real time.

Over The Air (OTA) Software Updates

Wirelessly updates software and parameters without disrupting your schedules, while increasing operational efficiency and uptime. Requires Mack GuardDog Connect.



Your truck should come on your terms. Take control with Mack's complete business services.

From financing to premium maintenance packages, Mack has what you need to get, and keep, your truck on the road.

MACK FINANCIAL SERVICES

Mack offers comprehensive financial services that include customized loans, leases and payment plans. You choose the terms, then Mack comes up with the payment plan and coverage that works for you, so you can build your business.

FLEET MANAGEMENT SERVICES

Mack's unique suite of offerings makes fleet management fast and easy. Mack partners with best-in-class software providers and telematics services to deliver the intelligent tools you need to manage your fleet.

MACK LEASING SYSTEM

Mack offers full-service leasing and rental services backed by our growing association of MLS dealer members. Whether you're looking to lease your fleet, rent a truck or outsource your maintenance, Mack has a variety of solutions to meet your needs.

PREMIUM MAINTENANCE PLANS

Mack takes the worry and hassle out of maintenance with premium plans that provide nationwide maintenance coverage at any authorized Mack dealer location. Select a plan and pay upfront so that your truck's interval maintenance is covered—no payment or paperwork required.

WARRANTY AND PROTECTION PLANS

Mack offers the most flexible warranty program in the industry. Whether you need a standard warranty or a premium protection plan, Mack can customize a plan to meet your specific business requirements.

**Let's
Haul.**

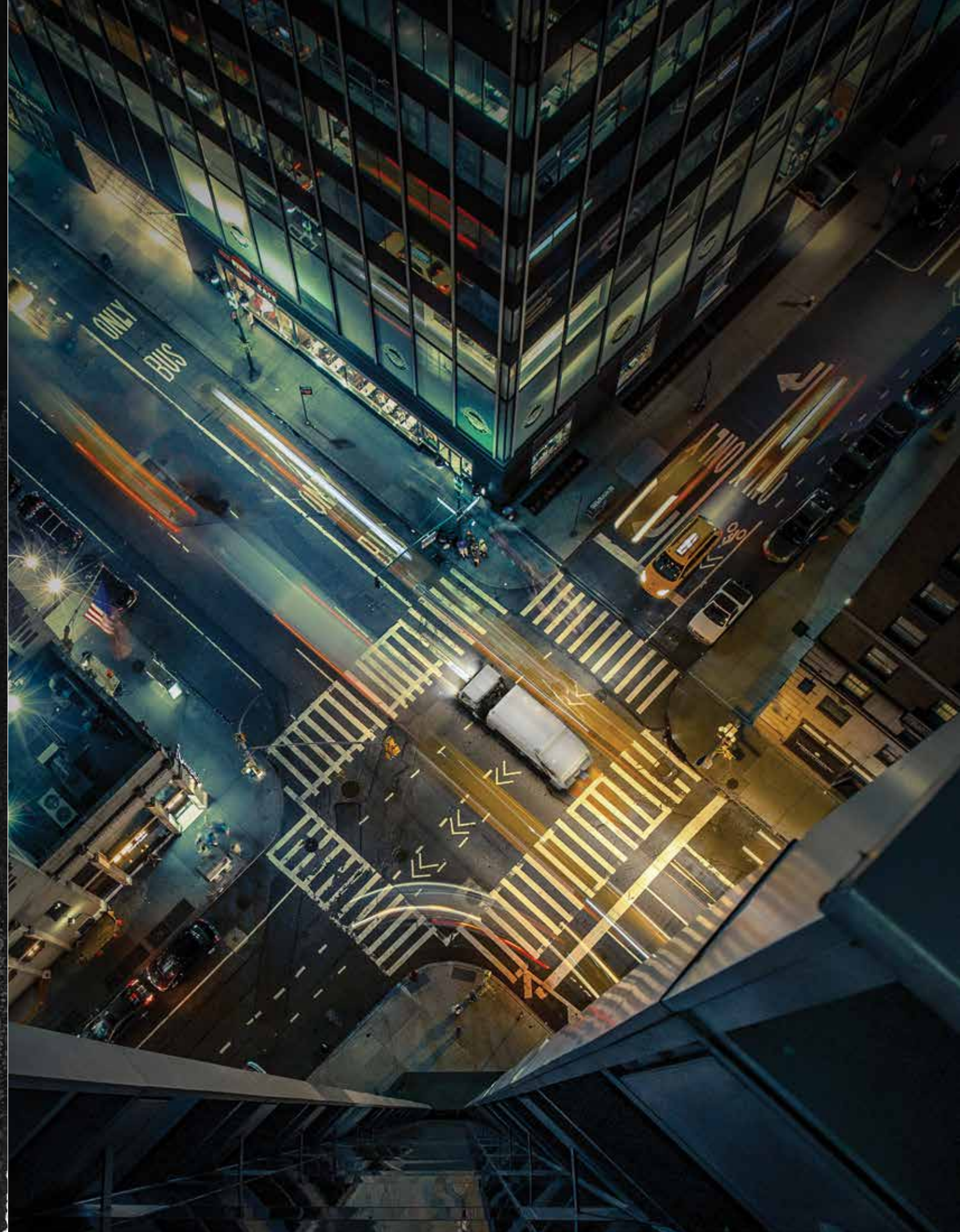





1-800-922-MACK
MackTrucks.com

©2019 Mack Trucks, Inc.

 facebook.com/MackTrucks

 twitter.com/MackTrucks

 youtube.com/MackTrucks

 linkedin.com/company/Mack-Trucks

 instagram.com/MackTrucks